

Keysight Technologies

E5052B Signal Source Analyzer

10 MHz to 7 GHz, 26.5 GHz, or 110 GHz

Data Sheet



Definitions

All specifications apply over a $23\text{ }^{\circ}\text{C} \pm 5\text{ }^{\circ}\text{C}$ range (unless otherwise stated) and 30 minutes after the instrument has been turned on.

All specified and supplemental values for RF input signals are applicable to sinusoidal-wave carriers unless otherwise noted.

Specification (spec.):

Warranted performance. Specifications include guard-bands to account for the expected statistical performance distribution, measurement uncertainties, and changes in performance due to environmental conditions.

Following supplemental information is intended to provide information that is helpful for using the instrument but that is not guaranteed by the product warranty.

Typical (typ.):

Describes performance that will be met by a minimum of 80% of all products. It is not guaranteed by the product warranty.

Supplemental performance data (SPD):

Represents the value of a parameter that is most likely to occur; the expected mean or average. It is not guaranteed by the product warranty.

General characteristics or nominal (nom.):

A general, descriptive term that does not imply a level of performance. It is not guaranteed by the product warranty.

RF Input Port

Table 1-1. RF IN port

Description	Specification
RF IN connector	Type-N (female), 50 ohm nominal
RF IN frequency range	10 MHz to 7 GHz
RF IN measurement level	-20 dBm to +20dBm (> 30 MHz) -15 dBm to +20 dBm (< 30 MHz)
Input attenuator	0 to 35 dB (in 5 dB step)
Input damage level	AC > +23 dBm, DC > 5V
Input VSWR @50 ohm	
10 MHz to 30 MHz	< 1.6
30 MHz to 2 GHz	< 1.2
2 GHz to 3 GHz	< 1.3
3 GHz to 4 GHz	< 1.3 typical
4 GHz to 7 GHz	< 1.5 typical

Phase Noise Measurement

Table 1-2. Phase noise measurement performance

Description	Specification (E5052B)	Specification (E5052B Option 011)
RF IN frequency range	10 MHz to 7 GHz	
Measurement frequency bands	10 MHz to 41 MHz, 39 MHz to 101 MHz, 99 MHz to 1.5 GHz, 250 MHz to 7 GHz ¹	
RF frequency tracking range	0.4% of carrier frequency	
Measurement parameters	SSB phase noise [dBc/Hz], Spurious noise [dBc], Integrated rms phase deviation [deg, rad] or time jitter [s], Residual FM [Hz rms]	
Number of trace	1 data trace and 1 memory trace with 'data math' functions	
Measurement trigger	continuous/single/hold	source: internal/external/manual/bus
Offset frequency range (effective)		
RF carrier signal > 1 GHz (> 400 MHz for wide capture mode)	1 Hz to 100 MHz 1 Hz to 40 MHz (wide capture mode)	10 Hz to 100 MHz 10 Hz to 40 MHz (wide capture mode)
RF carrier signal < 1 GHz (< 400 MHz for wide capture mode)	1 Hz to 10% of carrier frequency	10 Hz to 10% of carrier frequency
Phase noise uncertainty ² at effective offset frequencies		
Offset 1 Hz to 10 Hz	± 4 dB (SPD)	N/A
Offset 10 Hz to 100 Hz	± 4 dB (SPD)	
Offset 100 Hz to 1 kHz	± 3 dB	
Offset 1 kHz to 40 MHz	± 2 dB (± 3 dB for wide capture range mode)	
Offset 40 MHz to 100 MHz	± 3 dB	
SSB phase noise sensitivity	See Table 1-3, 1-4, 1-5, Figure 1-1, 1-2, 1-3	
IF gain setting	0 dB to 50 dB in 10 dB step (not available in wide capture mode)	0 dB to 30 dB in 10 dB step (not available in wide capture mode)
Enhanced sensitivity	Cross-correlation method available. Number of correlation = 1 to 10,000 See Table 1-5 and Figure 1-3	N/A
Built-in LO phase noise optimization	< 150 kHz (optimized for better close-in phase noise measurement) > 150 kHz (optimized for better far-out phase noise measurement) See Figure 1-4.	
Reference oscillator bandwidth optimization	Narrow / Wide See Figure 1-5.	
Residual spurious response level	< -80 dBc (SPD) at > 10 kHz offset frequency with correlation > 120 sec. except for 23.5 MHz ± 1 MHz and 71 MHz ± 3 MHz of carrier frequency < -65 dBc (typical) at 1 kHz to 10 kHz offset frequency	
Measurement time	See Table 1-6	
Measurement range	Capture mode: Normal or Wide	
PN mode (Regular)	RBW: Auto X-axis: Offset frequency in log scale	
Segment PN mode ³	RBW: 96 mHz to 25 kHz (stepped), Maximum offset frequency span: 93.2 Hz to 24.4 MHz (stepped) X-axis: Offset frequency in liner scale	N/A

1. Wide capture mode is available for 250 MHz to 7 GHz only
2. Phase noise uncertainty: specified at 10 MHz and 1 GHz of carrier frequency with 0 dBm level. PN level > -60 dBc
3. Segment PN mode is available with the firmware revision 3.20 or later. In this datasheet, specification of phase noise sensitivity, residual spurious response level and measurement time are applicable to the regular PN mode. In the segment PN mode, number of these parameters depend on the measurement setting. For more detail, refer to the user's manual.

Phase Noise Measurement – continued

Table 1-3. SSB phase noise sensitivity (dBc/Hz) in normal capture range mode (E5052B)

LO optimization: < 150 kHz, Ref. BW: narrow, correlation = 1, RF input: +5 dBm, start offset frequency: 1 Hz, measurement time = 12.9 sec

RF input frequency		Offset frequency [Hz] from the carrier									
		1	10	100	1 k	10 k	100 k	1 M	10 M	40 M	100 M
10 MHz	specification				-148	-156	-166	-168	–	–	–
	SPD	-100	-131	-151	-164	-172	-178	-178	–	–	–
100 MHz	specification				-147	-156	-163	-168	-170	–	–
	SPD	-80	-111	-136	-154	-164	-171	-175	-178	–	–
1 GHz	specification				-128	-137	-144	-160	-170	-168	-169
	SPD	-60	-91	-116	-135	-146	-155	-171	-178	-178	-177
3 GHz	specification				-118	-127	-133	-149	-163	-164	-165
	SPD	-50	-81	-106	-127	-135	-142	-161	-175	-177	-177
7 GHz	specification				-111	-120	-127	-143	-157	-158	-159
	SPD	-43	-74	-99	-121	-129	-138	-154	-171	-174	-175

Table 1-3-W. SSB phase noise sensitivity (dBc/Hz) in wide capture range mode (E5052B) (SPD)

LO optimization: < 150 kHz, Ref. BW: narrow, correlation = 1, RF input: +5 dBm, start offset frequency: 1 Hz, measurement time = 12.9 sec

RF input frequency		Offset frequency (Hz) from the carrier								
		1	10	100	1 k	10 k	100 k	1 M	10 M	40 M
1 GHz	SPD	–	–	–	-108	-128	-144	-155	-160	-160
3 GHz	SPD	–	–	–	-107	-119	-134	-150	-158	-158
7 GHz	SPD	–	–	–	-107	-112	-126	-146	-156	-156

Table 1-4. SSB phase noise sensitivity (dBc/Hz) in normal capture range mode (E5052B Option 011)

LO optimization: < 150 kHz, Ref. BW: narrow, correlation = 1, RF input: +5 dBm, start offset frequency: 10 Hz, measurement time = 3.3 sec

RF input frequency		Offset frequency [Hz] from the carrier								
		10	100	1 k	10 k	100 k	1 M	10 M	40 M	100 M
10 MHz	specification			-135	-147	-160	-160	–	–	–
	SPD	-120	-135	-151	-163	-170	-170	–	–	–
100 MHz	specification			-142	-152	-154	-156	-159	–	–
	SPD	-107	-128	-149	-160	-168	-170	-170	–	–
1 GHz	specification			-125	-134	-141	-157	-160	-160	-160
	SPD	-86	-111	-132	-143	-152	-168	-170	-170	-170
3 GHz	specification			-115	-124	-130	-146	-160	-160	-160
	SPD	-76	-101	-124	-132	-139	-158	-170	-170	-170
7 GHz	specification			-108	-117	-124	-140	-154	-155	-156
	SPD	-69	-94	-118	-126	-135	-151	-165	-170	-170

Table 1-5. SSB phase noise sensitivity improvement by correlation

Number of correlation	10	100	1,000	10,000
Improvement factor	5 dB	10 dB	15 dB	20 dB

Table 1-6. E5052B Typical measurement time (sec) for phase noise

LO optimization: < 150 kHz, Ref. BW: narrow, correlation = 1, RF input: +5 dBm

Stop frequency (Hz)	Start frequency (Hz)			
	1	10	100	1 k
100k	8.8	2.2	0.28	0.04
1M	8.8	2.2	0.28	0.04
10M	10	2.5	0.32	0.04
40M	10	2.5	0.32	0.04
100M	12.9	3.3	0.41	0.05

Measurement time (sec) = (0.4 (Capture range narrow) or 0.6 (Capture range wide)) + the above value x number of correlation when applying cross-correlation function (E5052B ONLY).

For E5052B Option 011, number of correlation = 1.

Phase Noise Measurement – continued

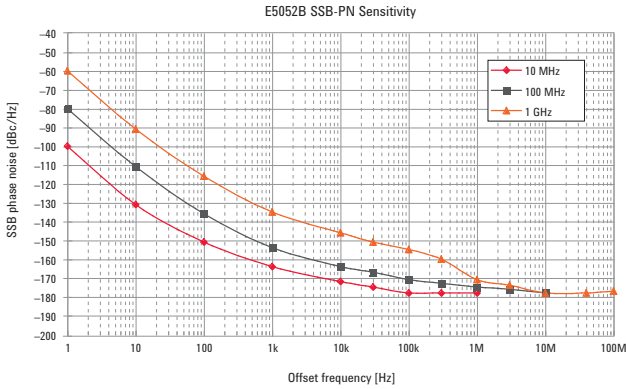

Figure 1-1. SSB phase noise sensitivity (E5052B, SPD) (LO < 150 kHz optimized, +5 dBm input, start offset frequency = 1 Hz, measurement time = 12.9 sec.)

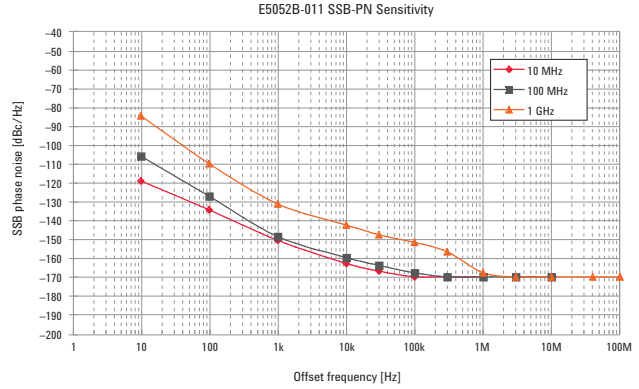

Figure 1-2. SSB phase noise sensitivity (E5052B Option 011, SPD) (LO < 150 kHz optimized, +5 dBm input, start offset frequency = 10 Hz, measurement time = 3.3 sec.)

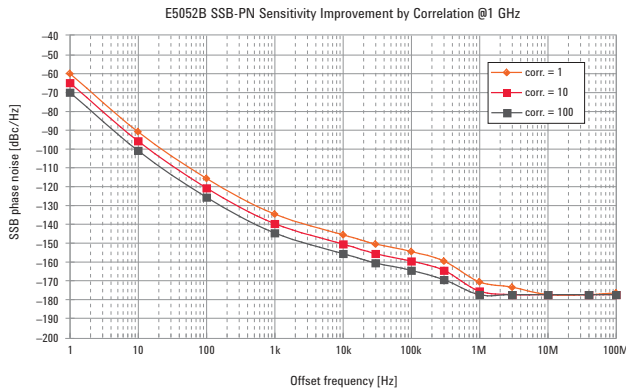

Figure 1-3. SSB phase noise sensitivity improvement by correlation (E5052B, SPD) (carrier 1 GHz, LO < 150 kHz optimized, +5 dBm input, start offset frequency = 1 Hz)

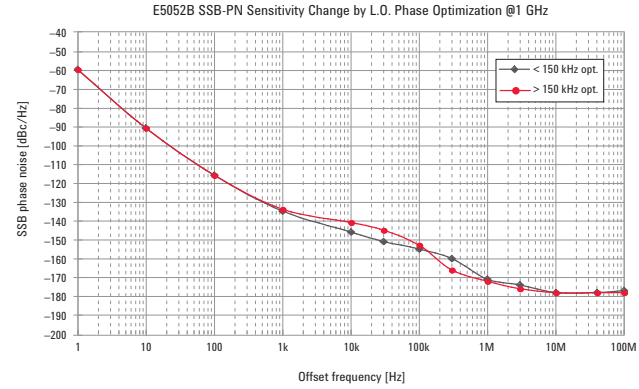

Figure 1-4. SSB phase noise change by LO optimization (SPD) (carrier 1 GHz, +5 dBm input, start offset frequency = 1 Hz, reference oscillator: narrowband)

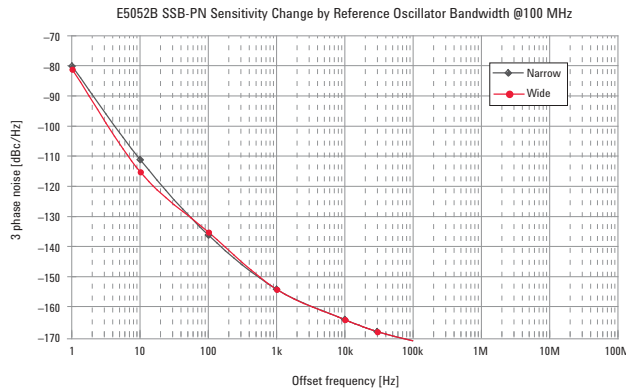

Figure 1-5. SSB phase noise sensitivity change by reference oscillator bandwidth (SPD) (carrier 100 MHz, +5 dBm input, start offset frequency = 1 Hz, LO optimization: < 150 kHz)

Spectrum Monitor Measurement

Table 2-1. Spectrum monitor performance

Description	Specification
RF frequency range	10 MHz to 7 GHz
Monitoring span	15 MHz maximum with linear scale
RBW	1.53 Hz to 400 kHz
Measurement parameters	dBm, dBV, watt, volt, dBm/Hz, dBV/Hz, watt/Hz, V/√Hz
Absolute measurement uncertainty	± 2 dB typical @ -10 dBm (att. = 10 dB)
Relative measurement uncertainty	± 1.5 dB (-60 dBm to -10 dBm, ratio)
Residual noise floor	-95 dBm typical @ RBW = 24.4 Hz
Measurement trigger	continuous/single/hold source: internal/external/manual/bus

Frequency and RF Power, DC Supply Current Measurements

Table 3-1. Frequency and power measurement performance

Description	Specification (E5052B)	Specification (E5052B-011)
RF frequency range	10 MHz to 7 GHz	
Measurement frequency bands	10 MHz to 1.5 GHz (low-band), 250 MHz to 7 GHz (high-band)	
Sweep parameters	DC control voltage (Vc) DC supply voltage (Vs)	N/A (Vc and Vs: constant)
Measurement parameters	Full analysis capability available for Frequency [Hz, ΔHz, %, ppm], Tuning sensitivity (Δf/ΔVc)[Hz/V], frequency pushing (Δf/ΔVs)[Hz/V], RF power level [dBm], DC supply current [A], 'Meter mode' is also available.	No 'Analysis mode'. Only 'Meter mode' is available. Frequency [Hz], RF power [dBm], DC supply current [A]
Frequency resolution	10 Hz, 1 kHz, 64 kHz	
Frequency uncertainty	± (frequency resolution + time-base uncertainty)	
RF power measurement range	-20 dBm to +20 dBm (carrier 30 MHz to 7 GHz) -15 dBm to +20 dBm (carrier 10 MHz to 30 MHz)	
RF power resolution	0.01 dB	
RF power uncertainty (by peak detection)	± 0.5 dB (carrier 30 MHz to 3 GHz, > -10 dBm) ± 1 dB (other than the above)	
DC (Vs) current measurement range	0 to 80 mA	
DC (Vs) current resolution	10 μA	
DC (Vs) current uncertainty	± (0.2% of reading + 160 μA)	
Swept measurement points	2 to 1,001	N/A
DC supply voltage source (Vs) output		
Setting range	0 to +16 V (sweep)	0 to +16 V (one point)
Setting resolution	1 mV	
Setting uncertainty	± (0.2% of setting + 2 mV)	
Maximum output current	80 mA	
Noise level	< 10 nVrms/√Hz @ 10 kHz typical	
Output resistance	< 0.3 ohm typical	
DC control voltage source (Vc) output		
Setting range	-15 V to +35 V (sweep)	-15 V to +35 V (one point)
Setting resolution	0.1 mV	
Setting uncertainty	± (0.1% of (setting + 15 V) + 5 mV) (@Vc = -15 V to 0V) ± (0.1% of setting + 2 mV) (@Vc = 0 to +35 V)	
Maximum output current	20 mA	
Noise level	1 nVrms/√Hz @ 10 kHz (Vc = 0 to +20V) 1.5 nVrms/√Hz @ 10 kHz (Vc: otherwise)	
Output resistance	< 50 ohm (DC)	
Output settling time	< 20 ms @ 0.1% uncertainty	
Measurement trigger	continuous/single/hold source: internal/external/manual/bus	

Transient Measurement

Table 4-1. Transient measurement performance

Description	Specification
Target frequency range	10 MHz to 7 GHz
Measurement parameters	
Narrowband mode	Frequency, RF power, phase
Wideband mode	Frequency
Frequency transient bandwidth	
Wideband	See Table 4-2.
Narrowband	3.125 kHz/ 25 kHz/ 200 kHz/ 1.6 MHz 25.6 MHz (> carrier 200 MHz) 80 MHz (> carrier 800 MHz)
Frequency measurement	
Resolution	See Table 4-2. through Table 4-8.
Uncertainty	± (resolution + time-base uncertainty)
Residual FM ¹	$0.2 f^{\frac{1}{3}} \sqrt{1 + 11 f^{\frac{2.5}{3}}} \text{ (Hz}_{\text{ms}}/\text{GHz}), \text{SPD}$ $f = \text{resolution}$
RF power measurement	
Power level range	-20 dBm to +20 dBm
Resolution	0.1 dB
Uncertainty	± 2 dB typical
Phase measurement (when DUT signal is locked to a target frequency)	
Uncertainty	0.1 deg + 0.1 deg/GHz typical
Trace noise	0.02 deg + 0.02 deg/GHz (s) typical
Stability	10 deg/sec typical
Sweep measurement time	
Time span	10 μs to 10 s in 1,2,5 step (in advanced mode: maximum time span = time resolution * 10,000. up to 1000 sec.)
Time resolution	See Table 4-2 through 4-8. in details 8 ns to 10 ms, See Table 4-2. to 4-8. in details
Measurement trigger	
Trigger mode	continuous/single/hold
Trigger source	internal/external/manual/bus/wide-video/narrow-video
External trigger polarity	positive/negative (TTL level)
Video trigger	positive/negative/frequency-band in/ frequency-band out
Video filter time-constant	160 ns to 41 μs
Pre-trigger delay	-80% of time span to + 1 s
External trigger delay adjustment	0 to 1 μs
External trigger detection jitter	< (1 μs + time resolution)

1. Equation is based on simplified model of phase noise characteristic of local oscillator in the E5052B.

Transient Measurement/Wideband Mode

Table 4-2. Wideband mode frequency resolution vs. time span and frequency band

Wideband mode				Transient time span (X-axis) setting																	
Time span [s]	10 μ	20 μ	50 μ	0.1 m	0.2 m	0.5 m	1 m	2 m	5 m	10 m	20 m	50 m	0.1	0.2	0.5	1	2	5	10		
Time resolution [s]	8 n	16 n	40 n	80 n	0.16 μ	0.4 μ	1 μ	2 μ	5 μ	10 μ	20 μ	50 μ	125 μ	250 μ	625 μ	1.25 m	2.5 m	6.25 m	12.5 m		
Measurement point	1251	1251	1251	1251	1251	1251	1001	1001	1001	1001	1001	1001	801	801	801	801	801	801	801		
Frequency band [GHz]				Frequency resolution [Hz]																	
0.05 to 0.15				28 k			9 k	3 k													1 k
0.1 to 0.3				56 k			19 k	7 k													2 k
0.2 to 0.6				112 k			39 k	14 k													4 k
0.3 to 0.9				168 k			59 k	21 k													7 k
0.4 to 1.2				225 k			79 k	28 k													9 k
0.5 to 1.5				281 k			99 k	35 k													12 k
0.6 to 1.8				337 k			119 k	42 k													14 k
0.8 to 2.4				450 k			159 k	56 k													19 k
1.0 to 3.0				562 k			198 k	70 k													24 k
1.2 to 3.6				675 k			238 k	84 k													29 k
1.4 to 4.2				787 k			278 k	98 k													34 k
1.6 to 4.8				900 k			318 k	112 k													39 k
1.8 to 5.4				1.012 M			357 k	126 k													44 k
2.0 to 6.0				1.125 M			397 k	140 k													49 k
2.2 to 6.6				1.237 M			437 k	154 k													54 k
2.4 to 7.2				1.35 M			477 k	168 k													59 k

Transient Measurement/Narrowband Mode

Table 4-3. Narrowband mode (80 MHz span)/frequency resolution vs. time span

Time span [s]	10 μ	20 μ	50 μ	0.1 m	0.2 m	0.5 m	1 m	2 m	5 m	10 m	20 m	50 m	0.1	0.2	0.5	1	2	5	10
Time resolution [s]	8 n	16 n	40 n	80 n	0.16 μ	0.4 μ	1 μ	2 μ	5 μ	10 μ	20 μ	50 μ	125 μ	250 μ	625 μ	1.25 m	2.5 m	6.25 m	12.5 m
Measurement point	1251	1251	1251	1251	1251	1251	1001	1001	1001	1001	1001	1001	801	801	801	801	801	801	801
Frequency resolution [Hz]	7 k					2.5 k		879											

Table 4-4. Narrowband mode (25.6 MHz span)/frequency resolution vs. time span

Time span [s]	10 μ	20 μ	50 μ	0.1 m	0.2 m	0.5 m	1 m	2 m	5 m	10 m	20 m	50 m	0.1	0.2	0.5	1	2	5	10	
Time resolution [s]	8 n	16 n	40 n	80 n	0.16 μ	0.4 μ	1 μ	2 μ	5 μ	10 μ	20 μ	50 μ	125 μ	250 μ	625 μ	1.25 m	2.5 m	6.25 m	12.5 m	
Measurement point	1251	1251	1251	1251	1251	1251	1001	1001	1001	1001	1001	1001	801	801	801	801	801	801	801	
Frequency resolution [Hz]	7 k				2.5 k		879		311											

Table 4-5. Narrowband mode (1.6 MHz span)/frequency resolution vs. time span

Time span [s]	0.1 m ¹	0.2 m ¹	0.5 m ¹	1 m	2 m	5 m	10 m	20 m	50 m	0.1	0.2	0.5	1	2	5	10
Time resolution [s]	0.13 μ	0.26 μ	0.64 μ	0.64 μ	1.28 μ	3.2 μ	6.4 μ	16 μ	80 μ	160 μ	320 μ	800 μ	1.6 m	3.2 m	8 m	16 m
Measurement point	783	783	783	1564	1564	1564	1564	1251	626	626	626	626	626	626	626	626
Frequency resolution [Hz]	110			39		13.7		4.9								

Table 4-6. Narrowband mode (200 kHz span)/frequency resolution vs. time span

Time span [s]	1 m	2 m	5 m	10 m	20 m ¹	50 m ¹	0.1 ¹	0.2 ¹	0.5 ¹	1	2	5	10 ¹
Time resolution [s]	1 μ ¹	2 μ ¹	5 μ ¹	10 μ ¹	20 μ ¹	51 μ ¹	128 μ	256 μ	640 μ	1.28 m	2.56 m	6.4 m	12.8 m
Measurement point	978	978	978	978	978	978	783	783	783	783	783	783	783
Frequency resolution [Hz]	4.9	4.9	1.72	0.61	0.21								

Table 4-7. Narrowband mode (25 kHz span)/frequency resolution vs. time span

Time span [s]	10 m	20 m	50 m ¹	0.1 ¹	0.2 ¹	0.5 ¹	1	2	5	10
Time resolution [s]	8.2 μ	16.4 μ	41 μ	82 μ	164 μ	410 μ	1.02 m	2.05 m	5.12 m	10.24 m
Measurement point	1222	1222	1222	1222	1222	1222	978	978	978	978
Frequency resolution [Hz]	0.21		0.08	0.03	0.01					

Table 4-8. Narrowband mode (3.125 kHz span)/frequency resolution vs. time span

Time span [s]	0.1 ¹	0.2 ¹	0.5 ¹	1	2	5	10
Time resolution [s]	65 μ ¹	131 μ ¹	328 μ ¹	655 μ ¹	1.31 m	3.3 m ¹	8.2 m ¹
Measurement point	1527	1527	1527	1527	1527	1527	1222
Frequency resolution [Hz]	0.01		3 m	1 m	0.4 m		

1. Means approximately

AM Noise Measurement

Table 5-1. AM noise measurement performance

Description	Specification
RF frequency range	60 MHz to 7 GHz
Effective offset frequency range	10 Hz to 40 MHz (@ > carrier 400 MHz) 10 Hz to 10% of carrier frequency (@ < carrier 400 MHz)
AM noise sensitivity	See Table 5-2.
Measurement uncertainty ¹	± 4 dB (100 Hz to 1 kHz offset) typical ± 2 dB (1 kHz to 1 MHz offset) typical ± 3 dB (1 MHz to 40 MHz offset) typical
Spurious level	< -65 dBc/Hz (at > 1 kHz offset) typical
Measurement trigger	continuous/single/hold source: internal/external/manual/bus

Table 5-2. AM noise sensitivity [dBc/Hz]

correlation = 1, RF input: 0 dBm, > 400 MHz

AM noise sensitivity	Offset frequency (Hz) from the carrier								
	1	10	100	1 k	10 k	100 k	1 M	10 M	40 M
E5052B start frequency = 1 Hz, measurement time = 13 s									
specification	-	-	-	-127	-138	-147	-150	-154	-155
typical	-	-103	-117	-131	-142	-151	-154	-158	-159
E5052B-011 (Option 011) start frequency = 10 Hz, measurement time = 3.3 s									
specification	-	-	-	-124	-135	-144	-147	-151	-152
typical	-	-100	-114	-128	-139	-148	-151	-155	-156

1. AM noise measurement uncertainty: specified at 10 MHz and 1 GHz of carrier frequency with 0 dBm level. AM level > -60 dBc

Baseband Noise Measurement

Table 6-1. Baseband noise measurement performance

Description	Specification
Baseband input connector	BNC, 50 ohm nominal, AC coupled
Measurement frequency range	1 Hz to 100 MHz (E5052B) 10 Hz to 100 MHz (E5052B Option 011)
Measurement parameters	dBV/Hz, dBm/Hz, V/ $\sqrt{\text{Hz}}$
Measurement level range	< +5 dBm
Baseband input damage level	> +23 dBm, > 35 V DC
Noise floor level	See Table 6-2.
Measurement uncertainty ¹	± 4 dB (< 1 kHz) SPD ± 2 dB (> 1 kHz) typical
Measurement trigger	continuous/single/hold source: internal/external/manual/bus

Table 6-2. Baseband noise floor [dBm/Hz]

correlation = 1, baseband input: 0 ohm terminated

BB noise floor	Baseband frequency [Hz]									
	1	10	100	1 k	10 k	100 k	1 M	10 M	40 M	100 M
E5052B start frequency = 1 Hz, measurement time = 13 s										
specification	–	–	–	–151	–158	–163	–160	–160	–156	–156
typical	–119	–132	–145	–155	–162	–167	–164	–164	–160	–160
E5052B Option 011 start frequency = 10 Hz, measurement speed = 3.3 s										
specification	–	–	–	–148	–155	–160	–157	–160	–156	–156
typical	–	–129	–142	–152	–159	–164	–161	–164	–160	–160

Internal Timebase

Table 7-1. Internal timebase (OCXO) performance

Description	Specification
Frequency uncertainty	± 5 Hz at 10 MHz (± 0.5 ppm)
Frequency temperature coefficient	< 0.5 ppb/degC
Frequency aging rate	< 0.5 ppb/day 24 hours after a cold start for < 30 days continuous operation

1. Baseband measurement uncertainty: specified at > –60 dBm level.

General Information

Table 8-1. Front panel information

Description	Supplemental information (nominal)
Connectors/terminals	
RF IN	Type-N (female), 50 ohm
Baseband IN	BNC (female), 50 ohm, AC coupled
DC power	BNC (female),
DC control	BNC (female), 50 ohm
RF1/RF2, IN/OUT	SMA (female), 50 ohm See the simplified block diagram.
USB	2 ports (designed for USB2.0)
Probe DC power output	+15 V, 150 mA maximum -12.6 V, 150 mA maximum
Ground terminal	1
Display	10.4 inch TFT color LCD with touch screen 1,024 x 768 resolution ¹

Table 8-2. Rear panel information

Description	Supplemental information (nominal)
External trigger input port	
Connector	BNC (female)
Input signal level	TTL level, (0 V to +5 V) Threshold Low: 0.5 V, High: 2.1V
Trigger pulse width	> 2 μ s
Trigger polarity	positive/negative edge selectable
Auxiliary output port	
Connector	BNC (female)
Output signal level	TTL level, L: 0 V, H: +5 V, 50 mA max.
pulse width	1 μ s
Reference output port	
Connector	BNC (female), 50 ohm
Output frequency	same as timebase
Output level	2.5 dBm \pm 2 dB typical
Output signal waveform	Sinusoidal wave
Reference input ports	
Connector	(Ref In 1, Ref In 2) BNC (female), 50 ohm
Input frequency	10 MHz \pm 10 Hz
Input signal level	0 dBm to 10 dBm
PC connection ports	
24 BIT I/O parallel port	36-pin D-sub (female) connector to a handler system TTL level, 8-bit I/O 16-bit Out
GPIB port	24-pin D-sub (female) connector (compatible with IEEE-488)
USB host ports	4 type-A (compatible with USB 2.0)
USB (USBTMC ²) port	1 type-B (compatible with USBTMC-USB488 and USB 2.0)
LAN port	10/100 base-T ethernet
Video output port	15-pin mini D-sub (female) connector drives XGA compatible monitors
AC power line (a third-wire ground is required)	
AC frequency	47 Hz to 63 Hz
AC voltage	90 to 132 V, or 198 to 264 V (automatically selected)
AC power	500 VA maximum

1. Valid pixels > 99.998%. Below 0.002% of fixed points of black, blue, green or red are not regarded as failures.
2. USB test and measurement class (TMC) interface that communicates over USB, complying with the IEEE-488.1 and IEEE-488.2 standards.

General Information – continued

Table 8-3. Analyzer environment and dimensions

Description	Supplemental information (nominal)
Operating environment	
Temperature	+10 degC to +40 degC
Humidity	RH 20% to 80% at wet bulb temp.< 29 degC (non-condensing)
Altitude	0 to 2,000 m (0 to 6,561 feet)
Vibration	0.21 G maximum, 5 Hz to 500 Hz
Non-operating storage environment	
Temperature	-10 degC to +60 degC
Humidity	RH 20% to 90% at wet bulb temp.< 40 degC (non-condensing)
Altitude	0 to 4,572 m (0 to 15,000 feet)
Vibration	0.5 G maximum, 5 Hz to 500 Hz
Instrument dimensions	See Figure 8-1, 8-2, 8-3.
Weight (NET)	24.5 kg

Table 8-4. LXI compliance







LXI	
	Class C (only applies to units that are shipped with firmware revision A.03.10 or later)

Table 8-5. EMC, safety, and WEEE

EMC	
	European Council Directive
ISM 1-A	89/336/EEC, 92/31/EEC, 93/68/EEC IEC 61326-1:1997 +A1:1998 +A2:2000 EN 61326-1:1997 +A1:1998 +A2:2001
	CISPR 11:1997 +A1:1999 +A2:2002 EN 55011:1998 +A1:1999 +A2:2002
	EN 61000-4-2:1995 +A1:1998 +A2:2001
	EN 61000-4-3:1995 +A1:1998 +A2:2001
	EN 61000-4-3:1996 +A1:1998 +A2:2001
	EN 61000-4-4:1995 +A1:2001 +A2:2001
	EN 61000-4-4:1995 +A1:2001 +A2:2001
	IEC 61000-4-5:1995 +A1:2001
	EN 61000-4-5:1995 +A1:2001
	IEC 61000-4-6:1996 +A1:2001
	EN 61000-4-6:1996 +A1:2001
	IEC 61000-4-11:1994 +A1:2001
	EN 61000-4-11:1994 +A1:2001
ICES/NMB-001	Group 1, Class A
	4 kV CD / 8 kV AD
N10149	3 V/m, 80-1000 MHz, 80% AM
	1 kV power / 0.5 kV signal
	0.5 kV normal / 1 kV common
	3 V, 0.15-80 MHz, 80% AM
	100% 1 cycle
	This ISM device complies with Canadian ICES-001:1998. Cet appareil ISM est conforme à la norme NMB-001 du Canada.
	AS/NZS 2064.1
	Group 1, Class A
Safety	
	European Council Directive
ISM 1-A	73/23/EEC, 93/68/EEC
	IEC 61010-1:2001
	EN 61010-1:2001
	IEC60825-1:1994
	Measurement category I
LR95111C	Pollution degree 2
	Indoor use
	Class 1 LED
	Measurement category I
	Pollution degree 2
	Indoor use
WEEE	
	European Council Directive
	2002/96/EC

General Information – continued

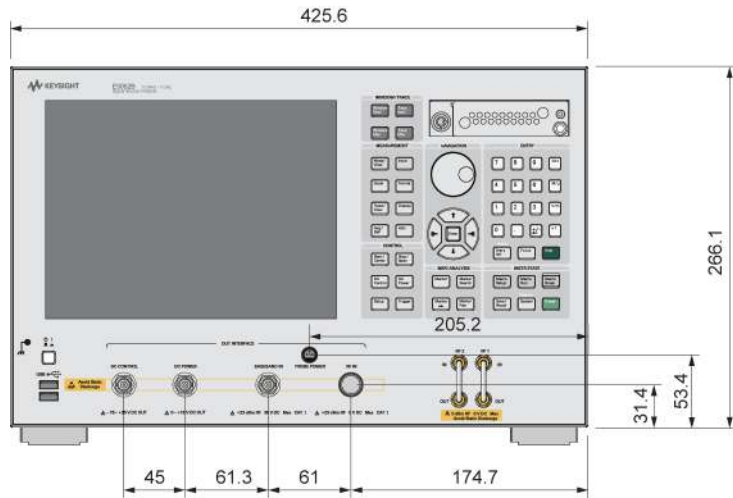

Figure 8-1. Front view

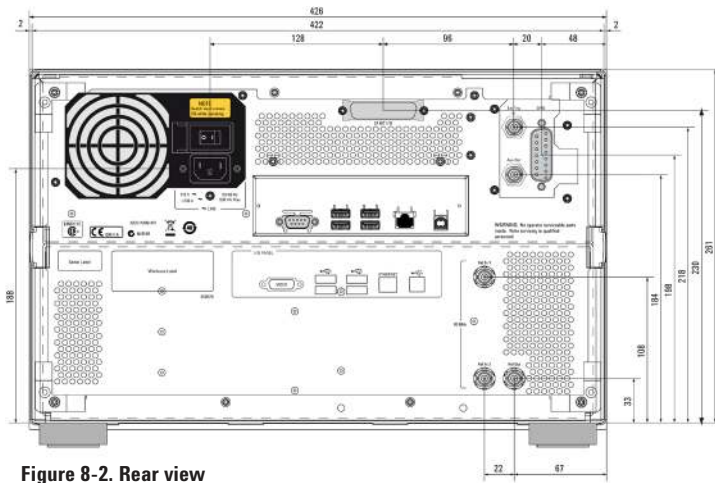

Figure 8-2. Rear view

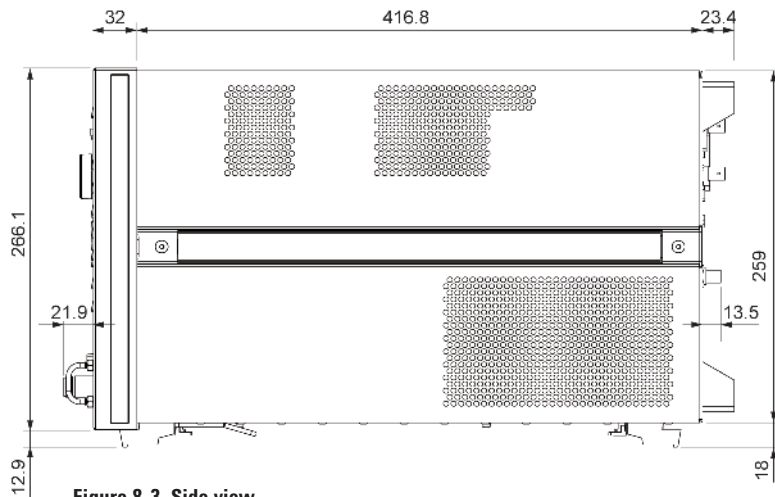

Figure 8-3. Side view

Display Functions

Table 9-1. Display functions (windows and traces)

Description	General characteristics
Measurement windows	Up to 6 windows, and 1 user definable window
User definable window	8 data traces and 8 memory traces
Trace functions	
Data traces	Display current measurement data and/or memory data
Trace math	Addition, subtraction, multiplication, or division of trace data
Title	Add customized title to each measurement window Titles are printed on hard copies of displayed measurements.
Auto scale	Automatically selects scale resolution and reference value to vertically center the trace.
Statistics	Calculates and displays mean, standard deviation, and peak-to-peak deviation of the trace.
Marker functions	
Data markers	10 independent markers per trace. Reference marker available for "delta marker" operation.
Marker search	Maximum value, minimum value, peak, peak-left, peak-right, target, target-left, target-right, multi-peak and band markers with user-definable bandwidth value.
Marker-to	Set, start, stop, center to active marker stimulus value. Set reference to active marker response value.
Searching range	User definable
Tracking	Performs marker search continuously or on-demand.

Data Processing Capabilities

Table 9-2. Data processing capabilities

Description	General characteristics
Graphical user interface	The analyzer employs a graphical user interface based on Windows® OS. There are three ways to operate the instrument manually; you can use a hard key interface, a touch-screen interface, or a mouse interface.
Limit-line test	Define the test limit that appears on the display for pass/fail testing. Defined limits may be any combination of horizontal or sloping lines and discrete data points.
Data storage	
Internal removable HDD	Store and recall instrument states and trace data on internal removable hard disk drive. Instrument states include all control settings and memory trace data.
File sharing	Files on user disk drive (F:) can be accessed from an external Windows PC through LAN or USB (USB-TMC)
Screen hard copy	Print-outs of instrument data are directly produced on a printer via USB.
Automation	
Built-in VBA®	Applications can be developed in a built-in VBA (Visual Basic for Applications) language.
Controlling via GPIB or USB	The GPIB interface operates with IEEE488.2 and SCPI protocols. The instrument can be controlled by a GPIB external controller. The instrument can control external devices using a USB/GPIB interface.
Controlling via USBTMC	The USB interface operates with USBTMC and SCPI protocols. The instrument can be controlled by an external PC using the USB interface with a USB cable.
LAN	(10/100 base-T) Telnet, SICL-LAN

Optional Application Software

Table 9-3. E5001A SSA-J precision clock jitter analysis software

Description	General characteristics
Measurement functions	RJ (random jitter), PJ (periodic jitter) frequency, PJ decomposition with auto-trend correction
Measurement parameters	RJ: rms, PJ: frequency, rms, p-p, δ - δ , TJ (total jitter): p-p, jitter trend (phase deviation waveform), jitter histogram
Jitter spectrum analysis range	1 Hz to 100 MHz (E5052B), 10 Hz to 100 MHz (E5052B Option 011)

System Performance with the E5053A Microwave Downconverter

The system performance is the combination of the E5052B SSA and the E5053A microwave downconverter. All data is typical performance.

Table 10-1. System performance characteristics

Description	Performance characteristics
RF input port	
Input connector	APC-3.5 (female), 50 ohm nominal (E5053A input)
Frequency range	10 MHz to 3 GHz (E5052B RF IN port) 3 to 26.5 GHz (E5053A Input port) 3 to 10 GHz frequency band: fundamental mixing 9 to 26.5 GHz frequency band: third harmonics mixing
Input level	-15 to +20 dBm (10 MHz to 3 GHz, E5052B RF IN port) -30 to +10 dBm (3 to 10 GHz frequency band) -20 to +5 dBm (9 to 26.5 GHz frequency band)
Carrier search range	-10 to +10 dBm (3 to 10 GHz frequency band) -10 to +5 dBm (9 to 26.5 GHz frequency band)
Phase noise measurement ¹	
SSB phase noise sensitivity	See Table 10-2, Figure 10-2 and Figure 10-3.
Frequency tracking range	1.8 MHz (< 4.9 GHz carrier in 3 to 10 GHz frequency band) 2.8 MHz (> 4.9 GHz carrier in 3 to 10 GHz frequency band) 1.3 MHz (< 10 GHz carrier in 9 to 26.5 GHz frequency band) 2.6 MHz (> 10 GHz carrier in 9 to 26.5 GHz frequency band)
Spectrum monitor measurement	
Frequency span	15 MHz maximum
RBW (resolution bandwidth)	1.53 Hz to 400 kHz
Level uncertainty	± 4 dB
Frequency & RF power measurement	
Frequency measurement resolution	10 Hz, 1 kHz, or 64 kHz
RF power measurement uncertainty	± 2 dB (10 MHz to 3 GHz, E5052B RF IN port) ± 3 dB (low band: 3 to 10 GHz) ± 4 dB (high band: 9 to 26.5 GHz) Power uncertainty can be improved by applying the 'user power cal.' function.
Transient measurement	
Wideband frequency range	50 MHz to 3 GHz (E5052B RF IN port) 500 MHz (E5053A Input port)
Narrowband frequency range	3.125 kHz, 25 kHz, 200 kHz, 1.6 MHz, 25.6 MHz, or 80 MHz
RF power measurement uncertainty	± 2 dB (10 MHz to 3 GHz, E5052B RF IN port) ± 3 dB (low band: 3 to 10 GHz) ± 4 dB (high band: 9 to 26.5 GHz) Power uncertainty can be improved by applying the 'user power cal.' function.

1. Segment PN mode is available with the firmware revision 3.20 or later. In segment PN mode, offset frequency range is limited up to 99.9 MHz when frequency range is 9 to 26.5 GHz frequency band.

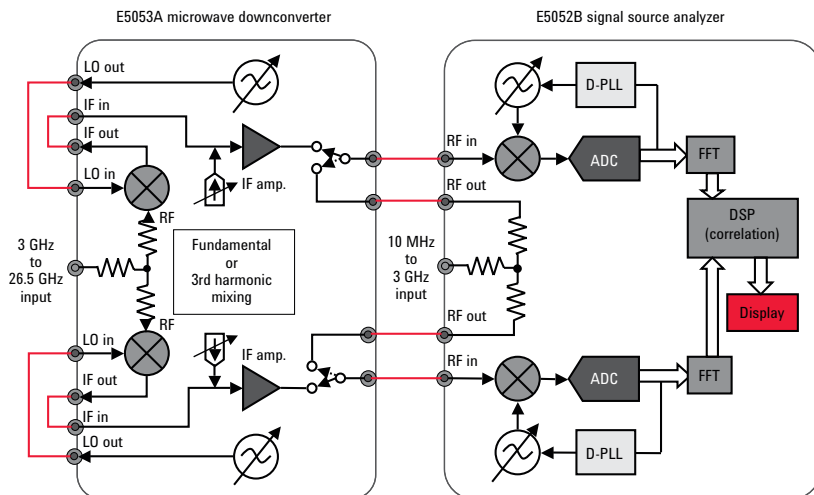

Figure 10-1. E5053A with E5052B simplified block diagram

System Performance with the E5053A Microwave Downconverter – continued

Table 10-2. System SSB phase noise sensitivity (dBc/Hz) in normal capture range mode (E5053A + E5052B) (SPD)

0 dBm input, start offset frequency = 1 Hz, correlation = 1, LO optimization: < 150 kHz, measurement time = 13 sec

Input frequency	Offset frequency (Hz) from the carrier									
	1	10	100	1 k	10 k	100 k	1 M	10 M	40 M	100 M
3 GHz	-48	-79	-99	-124	-135	-137	-153	-164	-167	-167
10 GHz	-38	-72	-91	-116	-124	-128	-147	-156	-160	-160
18 GHz	-33	-66	-85	-110	-121	-125	-141	-150	-154	-154
26.5 GHz	-30	-63	-82	-107	-118	-122	-138	-147	-151	-151

Table 10-2-W. System SSB phase noise sensitivity (dBc/Hz) in wide capture range mode (E5053A+E5052B) (SPD)

0 dBm input, start offset frequency = 1 Hz, correlation = 1, LO optimization: < 150 kHz, measurement time = 13 sec

Input frequency	Offset frequency (Hz) from the carrier									
	1	10	100	1 k	10 k	100 k	1 M	10 M	40 M	100 M
3 GHz	-	-	-	-107	-127	-136	-150	-158	-159	-159
10 GHz	-	-	-	-107	-122	-127	-146	-154	-157	-157
18 GHz	-	-	-	-105	-120	-124	-140	-149	-153	-153
26.5 GHz	-	-	-	-104	-117	-122	-137	-146	-150	-150

Table 10-2-A. System AM noise sensitivity (dBc/Hz) (E5053A + E5052B) (SPD)

correlation = 1, RF input: 0 dBm, > 400 MHz

AM noise sensitivity	Offset frequency (Hz) from the carrier									
	1	10	100	1 k	10 k	100 k	1 M	10 M	40 M	100 M
E5052B start frequency = 1 Hz, measurement time = 13 s										
3 to 10 GHz	-	-100	-110	-117	-127	-130	-137	-137	-137	-137
10 to 26.5 GHz	-	-100	-110	-117	-127	-129	-129	-129	-129	-129
E5052B-011 (Option 011) start frequency = 10 Hz, measurement time = 3.3 s										
3 to 10 GHz	-	-97	-107	-114	-124	-127	-134	-134	-134	-134
10 to 26.5 GHz	-	-97	-107	-114	-124	-126	-126	-126	-126	-126

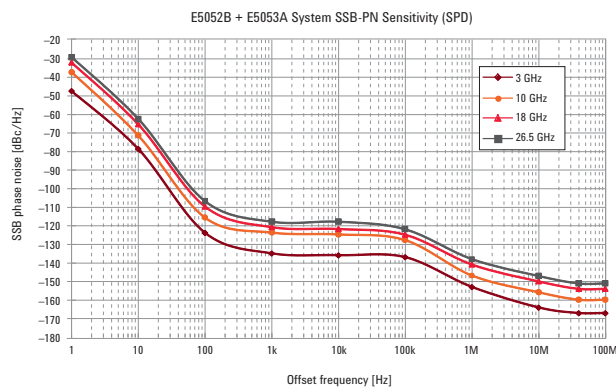

Figure 10-2. System phase noise sensitivity (E5053A + E5052B) (SPD)

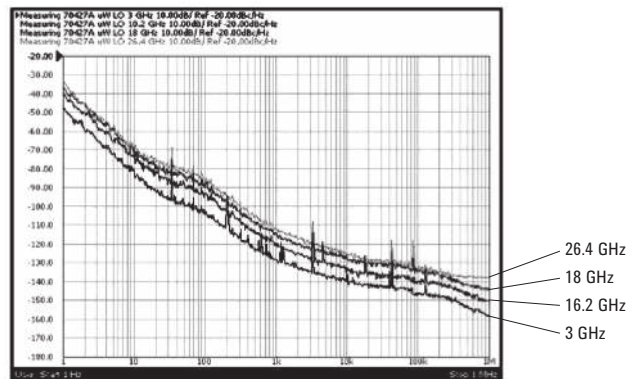

Figure 10-3. Measurement samples for the ultra-low noise N5507A LO

System Performance with the E5053A Microwave Downconverter – continued

About “mmW pplication”:

Phase noise measurements above 26.5 GHz can be done by using external harmonic mixers (such as Keysight Technologies, Inc. 11970 series) and a power divider (splitter) with E5053A LO and IF terminals. The E5052B’s mmW application software sets up appropriate LO frequencies for the harmonic mixers.

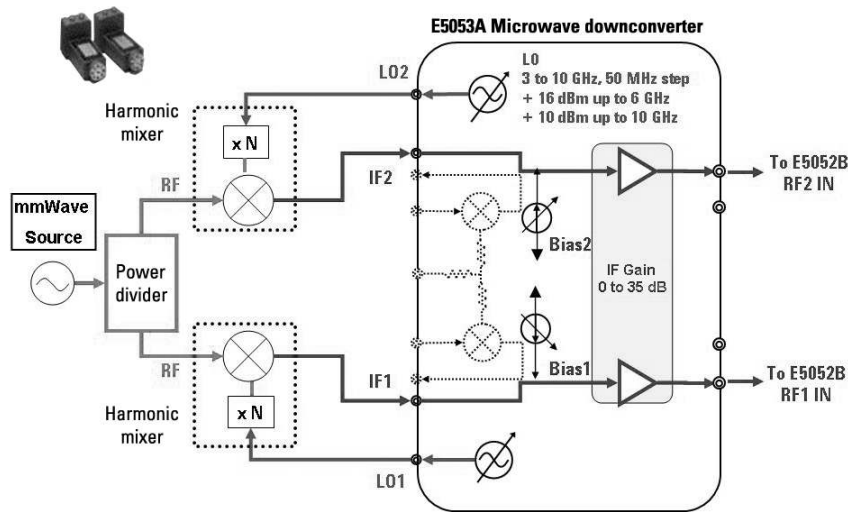

Figure 10-4. System set-up for harmonic mixers (E5053A + E5052B)

Table 10-2-H. Frequency band example of phase noise measurement with mmW harmonic mixers

Mixer model	Frequency band	N
11970A	26.5 to 40 GHz	8
11970Q	33 to 50 GHz	10
11970U	40 to 60 GHz	10
11970V	50 to 75 GHz	14
11970W	75 to 110 GHz	18

E5053A Microwave Downconverter Specifications and General Information Summary

Table 10-3. E5053A front ports

Description	Specification
RF Input port	
Input connector	APC-3.5 (female), 50 ohm nominal
Frequency range	3 GHz to 26.5 GHz 3 GHz to 10 GHz (fundamental mixing) 9 GHz to 26.5 GHz (third harmonics mixing)
Input level	< +10 dBm (3 GHz to 10 GHz band) < +5 dBm (9 GHz to 26.5 GHz band)
Input damage level	> +23 dBm
LO outputs	
Output connector	SMA (female), 50 ohm nominal
Output frequency	3 GHz to 10 GHz
Frequency resolution	50 MHz
Output power	10 dBm to 16 dBm (3 GHz to 6 GHz) 10 dBm to 15 dBm (6 GHz to 10 GHz)
LO spurious	< -55 dBc (offset frequency > 300 Hz) typical
IF inputs	
Input connector	SMA (female), 50 ohm nominal
Frequency range	250 MHz to 1,250 MHz
Maximum input level	0 dBm typical
IF gain	0 dB to 35 dB in 5 dB step
Noise floor	< -162 dBm/Hz (SPD)
Mixer bias current	-10 mA to +10 mA

Table 10-4. General information

Description	Supplemental information (nominal)
External reference signal input port	
Input connector	BNC (female), 50 ohm nominal
Input frequency	10 MHz \pm 10 Hz typical
Input level	-6 dBm to 6 dBm typical
Internal reference signal output port	
Output connector	BNC (female), 50 ohm nominal
Output frequency	10 MHz \pm 50 Hz typical
Output level	2.5 dBm \pm 3 dB typical
USB port	type-B (female), provides connection to E5052A/B
AC power Line (a third -wire ground is required)	
AC frequency	47 Hz to 63 Hz
AC voltage	90 V to 132 V, or 198 V to 264 V (automatically selected)
AC power	120 VA maximum

Table 10-5. Analyzer environmental and dimensions

Description	Supplemental information (nominal)
Operating environment	
Temperature	+10 degC to +40 degC
Humidity	RH 20% to 80% at wet bulb temp. < 29 degC (non-condensing)
Altitude	0 to 2,000 m (0 to 6,561 feet)
Vibration	0.21 G maximum, 5 Hz to 500 Hz
Non-operating storage environment	
Temperature	-10 degC to +60 degC
Humidity	RH 20% to 90% at wet bulb temp. < 40 degC (non-condensing)
Altitude	0 to 4,572 m (0 to 15,000 feet)
Vibration	0.5 G maximum, 5 Hz to 500 Hz
Instrument dimensions	See Figure 10-6, 10-7, 10-8.
Weight (NET)	11 kg

E5053A Microwave Downconverter Specifications and General Information Summary – continued

Table 10-6. E5053A LO phase noise performance (dBc/Hz)

RF input frequency		Offset frequency [Hz] from the carrier									
		1	10	100	1 k	10 k	100 k	1 M	10 M	40 M	100 M
3 GHz	specification	–	–	–	–110	–116	–113	–127	–140	–140	–140
	typical	–49	–79	–94	–114	–120	–117	–131	–144	–144	–144
6 GHz	specification	–	–	–	–104	–110	–109	–123	–140	–140	–140
	Typical	–43	–73	–88	–108	–114	–113	–127	–144	–144	–144
10 GHz	specification	–	–	–	–100	–103	–102	–119	–140	–140	–140
	typical	–39	–69	–84	–104	–107	–106	–123	–144	–144	–144

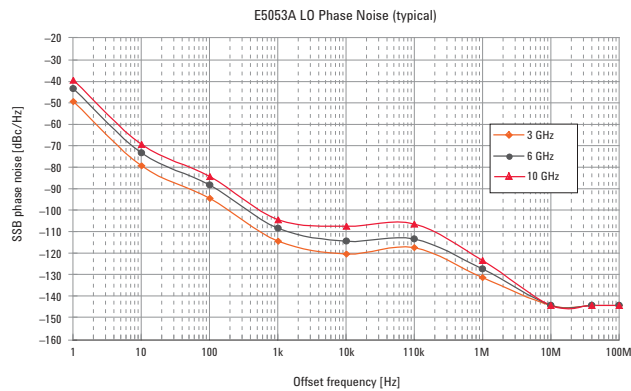

Figure 10-5. E5053A LO phase noise (typical)

Web Sources

Visit our Signal Source Analyzer Web site for additional product information and literature.

<http://www.keysight.com/find/ssa>

Phase noise measurements;

<http://www.keysight.com/find/phasenoise>

Jitter measurements;

<http://www.keysight.com/find/jitter>

RF and microwave accessories

<http://www.keysight.com/find/accessories>

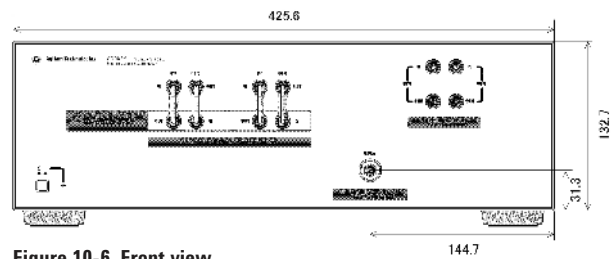

Figure 10-6. Front view

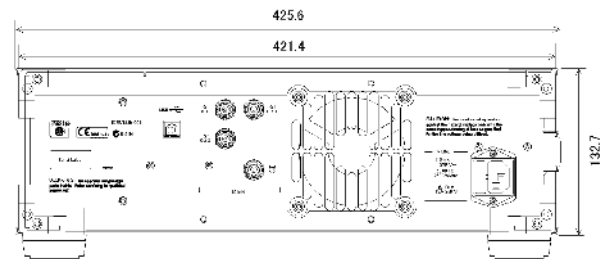

Figure 10-7. Rear view

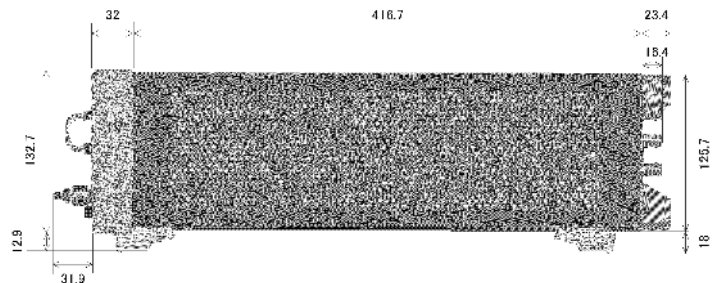

Figure 10-8. Side view

myKeysight

myKeysight

www.keysight.com/find/mykeysight

A personalized view into the information most relevant to you.



www.lxistandard.org

LAN eXtensions for Instruments puts the power of Ethernet and the Web inside your test systems. Keysight is a founding member of the LXI consortium.



Three-Year Warranty

www.keysight.com/find/ThreeYearWarranty

Keysight's commitment to superior product quality and lower total cost of ownership. The only test and measurement company with three-year warranty standard on all instruments, worldwide.



Keysight Assurance Plans

www.keysight.com/find/AssurancePlans

Up to five years of protection and no budgetary surprises to ensure your instruments are operating to specification so you can rely on accurate measurements.



www.keysight.com/quality

Keysight Technologies, Inc.
DEKRA Certified ISO 9001:2008
Quality Management System

Keysight Channel Partners

www.keysight.com/find/channelpartners

Get the best of both worlds: Keysight's measurement expertise and product breadth, combined with channel partner convenience.

www.keysight.com/find/ssa

www.keysight.com/find/phasenoise

www.keysight.com/find/jitter

www.keysight.com/find/accessories

For more information on Keysight Technologies' products, applications or services, please contact your local Keysight office. The complete list is available at: www.keysight.com/find/contactus

Americas

Canada	(877) 894 4414
Brazil	55 11 3351 7010
Mexico	001 800 254 2440
United States	(800) 829 4444

Asia Pacific

Australia	1 800 629 485
China	800 810 0189
Hong Kong	800 938 693
India	1 800 112 929
Japan	0120 (421) 345
Korea	080 769 0800
Malaysia	1 800 888 848
Singapore	1 800 375 8100
Taiwan	0800 047 866
Other AP Countries	(65) 6375 8100

Europe & Middle East

Austria	0800 001122
Belgium	0800 58580
Finland	0800 523252
France	0805 980333
Germany	0800 6270999
Ireland	1800 832700
Israel	1 809 343051
Italy	800 599100
Luxembourg	+32 800 58580
Netherlands	0800 0233200
Russia	8800 5009286
Spain	0800 000154
Sweden	0200 882255
Switzerland	0800 805353
	Opt. 1 (DE)
	Opt. 2 (FR)
	Opt. 3 (IT)
United Kingdom	0800 0260637

For other unlisted countries:
www.keysight.com/find/contactus
(BP-07-10-14)

